

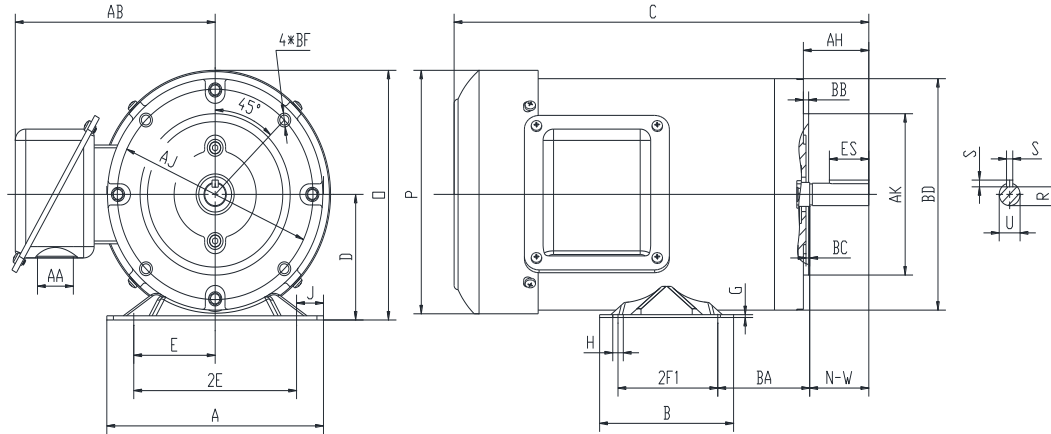

F56C1/3M2A

GENERAL PURPOSE ELECTRIC MOTOR
HIGH EFFICIENCY / EISA COMPLIANT
ROLLED STEEL CONSTRUCTION
TOTALLY ENCLOSED FAN COOLED
INVERTER RATED (10:1 VT; 5:1 CT)



DIMENSIONS

HP	RPM	Frame	MOUNTING														
			A	B	C	D	G	H	J	E	2E	2F1	2F2	O	P	T	BA
1/3	3600	56C	6.3	4	10.7	3.5	0.12	0.34	0.71	2.44	4.88	3	NA	7	6.8	NA	2.75

FLANGE							Shaft Extension, Key Set						
AH	AJ	AK	BB	BC	BD	BF	U	V	R	S	ES	N-W	
2.06	5.875	4.5	0.16	0.19	6.46	4*3/8-16	0.625	NA	0.517	0.188	1.41	1.88	

Conduit Box		Bearings		Mount
AA	AB	DE	ODE	
1.1	6	6203-2RZC3	6203-2RZC3	F1

BEARING LUBRICATION: The bearings come lubricated with Mobil Polyrex EM Polyurea Grease.





F56C1/3M2A

GENERAL PURPOSE ELECTRIC MOTOR
HIGH EFFICIENCY / EISA COMPLIANT
ROLLED STEEL CONSTRUCTION
TOTALLY ENCLOSED FAN COOLED
INVERTER RATED (10:1 VT; 5:1 CT)





PERFORMANCE DATA

HP	RPM	Frame	Voltage	Frequency (Hz)	Full Load S.F.	Insulation Class	NEMA Design	Slip (%)	NEMA Code	Enclosure Type	IP Rating	Max. Ambient
1/3	3480	56C	230/460	60	1.15	F	B	3.3	L	TEFC	55	40 °C

Amps (460V)		Efficiency (%)			Power Factor			Torque (ft-lb)			DE Bearing	ODE Bearing	Connection	Weight (lbs.)
FLA	LRA	100%	75%	50%	100%	75%	50%	FLT	LRT %	BDT %				
0.66	3.86	67.6	62.3	53.8	0.70	0.63	0.53	0.51	436	407	6203-2RZC3	6203-2RZC3	9 Lead 2Y/Y	17

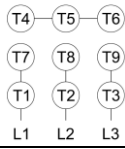
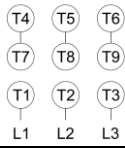
*Usable at 208 Volts

NAME PLATE

		THREE PHASE AC INDUCTION MOTOR											
CAT NO:	F56C1/3M2A	FRAME	56C	PH	3	230V							
HZ	60	S.F.	1.15	ENCL	TEFC	IP	55						
HP	1/3	RPM	3480	DUTY	CONT	DES	B						
VOLT	230/460	AMB	40 °C	INS	F								
FLA	1.32/0.66	DE BRG	6203-2RZC3			460V							
CODE	L	P.F.	0.70	ODE BRG	6203-2RZC3								
EFF	67.6	MIN	49.1	LBS	17								
CONNECTION	9 Lead 2Y/Y		SER NO.										
Hernando, MS www.naemotors.com													

APPLICATIONS:

General purpose use on pumps, fans, blowers, compressors, conveyors, material handling and other industrial machinery installed in damp, dusty or dirty environments.