

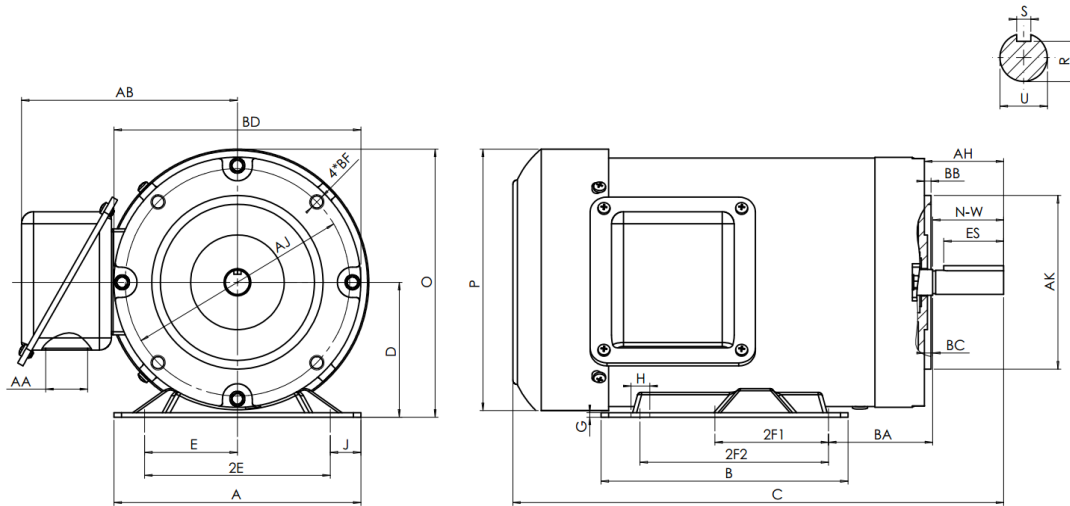

F56C1/3M4A

GENERAL PURPOSE ELECTRIC MOTOR
HIGH EFFICIENCY / EISA COMPLIANT
ROLLED STEEL CONSTRUCTION
TOTALLY ENCLOSED FAN COOLED
INVERTER RATED (10:1 VT; 5:1 CT)



DIMENSIONS

HP	RPM	Frame	MOUNTING														
			A	B	C	D	G	H	J	E	2E	2F1	2F2	O	P	T	BA
1/3	1800	56C	6.3	4	10.7	3.5	0.12	0.35	0.71	2.44	4.88	3	NA	7	6.8	NA	2.75

FLANGE							Shaft Extension, Key Set						
AH	AJ	AK	BB	BC	BD	BF	U	V	R	S	ES	N-W	
2.06	5.875	4.5	0.16	0.19	6.5	4*3/8-16	0.625	NA	0.517	0.188	1.41	1.88	

Conduit Box		Bearings		Mount
AA	AB	DE	ODE	
1.1	5.75	6203-2RZC3	6203-2RZC3	F1

BEARING LUBRICATION: The bearings come lubricated with Mobil Polyrex EM Polyurea Grease.





F56C1/3M4A





GENERAL PURPOSE ELECTRIC MOTOR
HIGH EFFICIENCY / EISA COMPLIANT
ROLLED STEEL CONSTRUCTION
TOTALLY ENCLOSED FAN COOLED
INVERTER RATED (10:1 VT; 5:1 CT)

PERFORMANCE DATA

HP	RPM	Frame	Voltage	Frequency (Hz)	Full Load S.F.	Insulation Class	NEMA Design	Slip (%)	NEMA Code	Enclosure Type	IP Rating	Max. Ambient
1/3	1740	56C	208-230/460	60	1.15	F	B	3.3	M	TEFC	55	40 °C

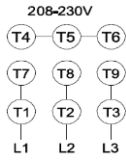
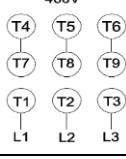
Amps (460V)		Efficiency (%)			Power Factor			Torque (ft-lb)			DE Bearing	ODE Bearing	Connection	Weight (lbs.)
FLA	LRA	100%	75%	50%	100%	75%	50%	FLT	LRT %	BDT %				
0.82	3.22	66.1	62.7	54.3	0.58	0.48	0.38	1.01	209	312	6203-2RZC3	6203-2RZC3	9 Lead 2Y/Y	17

NAME PLATE

		THREE PHASE AC INDUCTION MOTOR											
CAT NO:	F56C1/3M4A	FRAME	56C	PH	3								
HZ	60	S.F.	1.15	ENCL	TEFC	IP	55						
HP	1/3	RPM	1740	DUTY	CONT	DES	B						
VOLT	208-230/460	AMB	40 °C	INS	F								
FLA	1.52-1.61/0.8	DE BRG	6203-2RZC3										
CODE	M	P.F.	0.58	ODE BRG	6203-2RZC3								
EFF	66.1	MIN	56.8	LBS	17								
CONNECTION	9 Lead 2Y/Y	SER NO.											
Hernando, MS www.naemotors.com													

APPLICATIONS:

General purpose use on pumps, fans, blowers, compressors, conveyors, material handling and other industrial machinery installed in damp, dusty or dirty environments.