

NBS-307-6-25

SHAFT MOUNT GEAR REDUCER

BOX SIZE 6
 RATIO 25:1

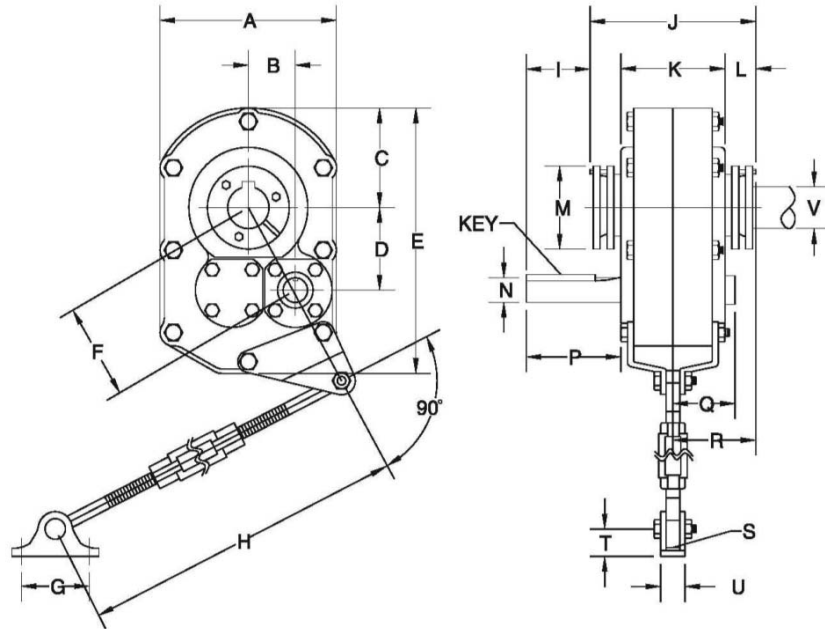

Box Size	Ratio	DIMENSIONS										
		A	B	C	D	E	F	G	H min/max	I	J	K
6	25:1	15.43	4.09	7.56	6.73	21.31	7.88	4.75	29.19 / 35.19	3.73	11.53	6.88

DIMENSIONS							INPUT SHAFT			Weight (Lbs.)
L	M	R	S	T	U	V Max Dia	N Dia	P	Key	
2.30	6.13	5.73	0.63	2.00	2.75	3-7/16"	2.19	6.08	1/2 x 1/2 x 4-1/2	285

NOTE: Torque Arm is included with shaft mount gear reducer.

Optional accessories include:

- Belt Guard**
- Motor Mount**
- Backstops**
- Tapered Bushings**
- Screw Conveyor Adaptor**



NBS-307-6-25

SHAFT MOUNT GEAR REDUCER

BOX SIZE 6
 RATIO 25:1

LUBRICATION INSTRUCTIONS

MOUNTING POSITION	A	B	C	D	E	F
QUARTS	4.300	5.200	4.250	5.000	8.630	9.130
LITERS	4.000	4.700	4.000	4.700	8.200	8.600

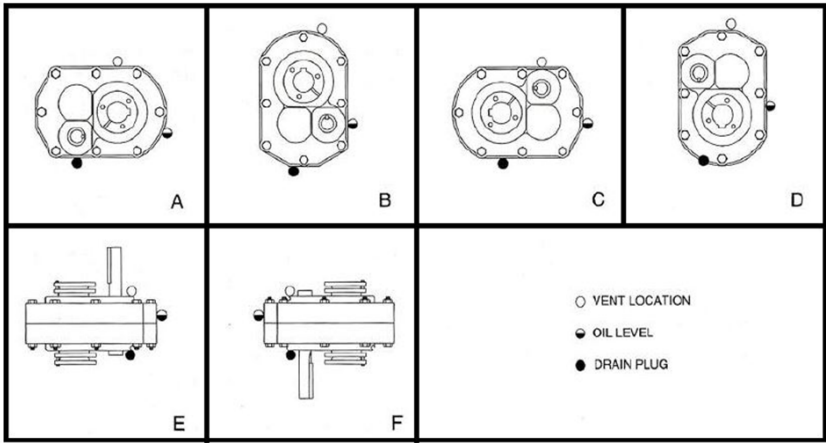

CAUTION

North American Electric Shaft Mount Gear Reducers are SHIPPED WITHOUT OIL. The Reducer must be filled with the proper amount of oil according to the mounting position table above. Failure to fill the case with oil could result in the failure of the reducer and damage to the associated equipment.