



OWP326T-30-6

OIL WELL PUMP MOTOR

HIGH TORQUE / HIGH SLIP (5 - 8%)

TOTALLY ENCLOSED FAN COOLED

INVERTER DUTY 10:1 CONSTANT TORQUE - NEMA MG1 PART 31

Factory Certified for T2B Class I, Division II, Groups A,B,C & D and Class II, Division II, Groups F & G

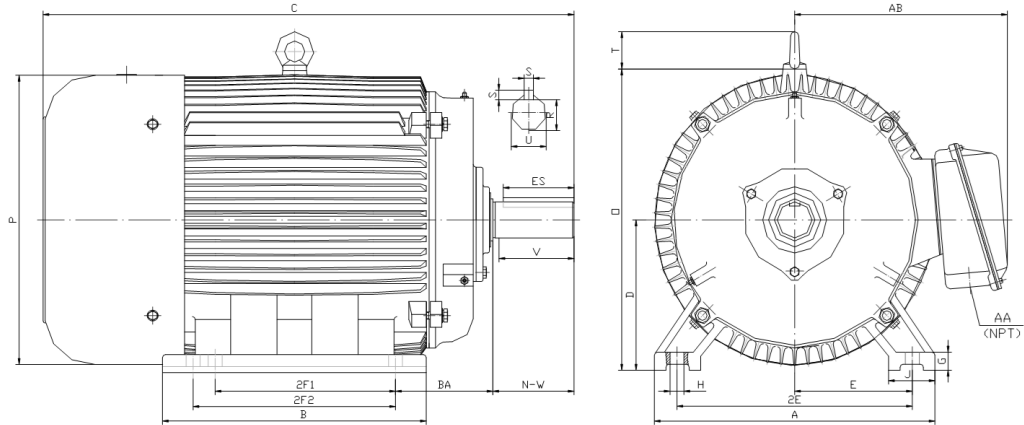

DIMENSIONS

HP	RPM	Frame	MOUNTING														
			A	B	C	D	G	H	J	E	2E	2F1	2F2	O	P	T	BA
30	1200	326T	15.5	14.7	31.3	8	1	0.66	2.75	6.25	12.5	10.5	12	15.9	15.7	2.6	5.25

Shaft Extension, Key Set						Conduit Box		Bearings		Mount
U	V	R	S	ES	N-W	AA	AB	DE	ODE	
2.125	5	1.845	0.5	3.91	5.25	2	12.3	6312	6312	F2

BEARING LUBRICATION: The bearings come lubricated with Mobil Polyrex EM Polyurea Grease. It is recommended that you add some additional lubrication when the motor is installed.

Three options (brands) for suitable lubrication include, but are not limited to, the following:

- 1.) Mobil Polyrex EM
- 2.) Citco Polyurea MP
- 3.) Conoco Phillips Polytac EP





OWP326T-30-6

OIL WELL PUMP MOTOR

HIGH TORQUE / HIGH SLIP (5 - 8%)

TOTALLY ENCLOSED FAN COOLED

INVERTER DUTY 10:1 CONSTANT TORQUE - NEMA MG1 PART 31





Factory Certified for T2B Class I, Division II, Groups A,B,C & D and Class II, Division II, Groups F & G

PERFORMANCE DATA

HP	RPM	Frame	Voltage	Frequency (Hz)	Full Load S.F.	Insulation Class	NEMA Design	Slip (%)	NEMA Code	Enclosure Type	IP Rating	Max. Ambient
30	1130	326T	230/460/796	60	1.15	F	D	5.8	G	TEFC	55	40 °C

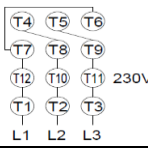
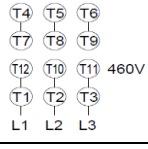
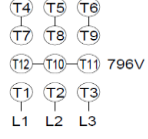
Amps (460V)		Efficiency (%)			Power Factor			Torque (ft-lb)			DE Bearing	ODE Bearing	Connection	Weight (lbs.)
FLA	LRA	100%	75%	50%	100%	75%	50%	FLT	LRT %	BDT %	6312	6312	12 Lead 2Δ/Δ/Y	572
38.5	217	86.5	87.0	86.4	0.85	0.76	0.61	139.5	300	330				

NAME PLATE

		OIL WELL PUMP MOTOR AC INDUCTION MOTOR INVERTER DUTY 20:1 VT; 10:1 CT				
TYPE	TEFC	MODEL	OWP326T-30-6	S.F.	1.15	
HP	30	FRAME	326T	EFF	86.5	
RPM	1130	VOLTS	230/460/796	P.F.	0.85	
INS	F	AMPS	77/38.5/22.2	CODE	G	
PH	3	MAX AMB	40 °C	DE BRG	6312	
HZ	60	S/N		ODE BRG	6312	
WT/LBS	572	DESIGN	D	CONNECTION	12 Lead 2Δ/Δ/Y	
Thermo-protection 155°C (PT1,PT2)			LUB	Mobil Polyrex EM		
Designed Specifically for use on Oil Well Pumping Units Hernando, Mississippi			  			

APPLICATIONS:

Designed Specifically for use on Oil Well Pumping Units. Suitable for use on Variable Frequency Drives (VFDs).