



PE254TC-15-4-RB-AI

GENERAL PURPOSE ELECTRIC MOTOR

NEMA PREMIUM EFFICIENCY

THREE PHASE, TOTALLY ENCLOSED FAN COOLED - C-FLANGE

INVERTER DUTY 10:1 CT; 20:1 VT - NEMA MG1 PART 31

Factory Certified for T2B Class I, Division II, Groups A,B,C & D and Class II, Division II, Groups F & G

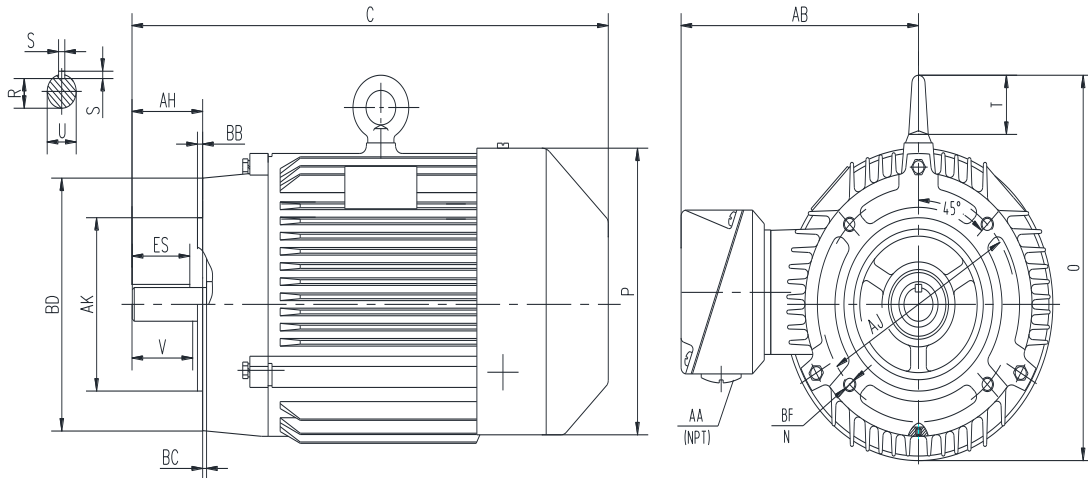

DIMENSIONS

HP	RPM	Frame	MOUNTING														
			A	B	C	D	G	H	J	E	2E	2F1	2F2	O	P	T	BA
15	1800	254TC	NA	NA	25.70	NA	NA	NA	NA	NA	NA	NA	NA	NA	14.02	2.05	NA

FLANGE							Shaft Extension, Key Set						Conduit Box		Bearings		Mount
AH	AJ	AK	BB	BC	BD	BF	U	V	R	S	ES	N-W	AA	AB	DE	ODE	
3.75	7.250	8.50	0.25	0.25	10.00	4*1/2-13	1.625	3.75	1.416	0.375	2.91	4.00	1.25	11.22	6309	6309	F1

BEARING LUBRICATION: The bearings come lubricated with Mobil Polyrex EM Polyurea Grease. It is recommended that you add some additional lubrication when the motor is installed.

Three options (brands) for suitable lubrication include, but are not limited to, the following:

- 1.) Mobil Polyrex EM
- 2.) Citco Polyurea MP
- 3.) Conoco Phillips Polytac EP





PE254TC-15-4-RB-AI

GENERAL PURPOSE ELECTRIC MOTOR

NEMA PREMIUM EFFICIENCY

THREE PHASE, TOTALLY ENCLOSED FAN COOLED - C-FLANGE

INVERTER DUTY 10:1 CT; 20:1 VT - NEMA MG1 PART 31

Factory Certified for T2B Class I, Division II, Groups A,B,C & D and Class II, Division II, Groups F & G

PERFORMANCE DATA

HP	RPM	Frame	Voltage	Frequency (Hz)	Full Load S.F.	Insulation Class	NEMA Design	Slip (%)	NEMA Code	Enclosure Type	IP Rating	Max. Ambient
15	1750	254TC	230/460	60	1.15	F	B	2.8	G	TEFC	55	40° C

Amps (460V)		Efficiency (%)				Power Factor			Torque (ft-lb)			DE Bearing	ODE Bearing	Connection	Weight (lbs.)
FLA	LRA	100%	75%	50%	Min.	100%	75%	50%	FLT	LRT %	BDT %				
18.0	116.0	92.4	92.2	92.0	91.0	0.860	0.850	0.750	44.8	185	230	6309	6309	12 Lead 2Δ/Δ	328

*Usable at 208 Volts

NAME PLATE

		AC INDUCTION MOTOR INVERTER DUTY 20:1 VT; 10:1 CT						CONNECTION DIAGRAMS	
CAT NO: PE254TC-15-4-RB-AI		FRAME 254TC		PHASE 3					
HZ 60	S.F. 1.15	HZ 50	S.F. 1.0	ENCL TEFC	IP 55				
HP 15	RPM 1750	HP 15	RPM 1470	DUTY CONT	DES B				
VOLTS 230/460		VOLTS 190/380		AMB 40° C	INS F				
FLA 36 / 18	FLA 45.8/22.9		DE BEARING 6309						
CODE G	P.F. 0.86	CODE H	P.F. 0.86	ODE BEARING 6309					
EFF 92.4	MIN 91.0	EFF 91.7	MIN 90.2	LUB: Mobil Polyrex EM					
MOTOR WEIGHT 328 LBS	CONNECTION 12 Lead 2Δ/Δ		SER NO						
General purpose use on industrial machinery installed in damp, dusty or dirty environments. Hernando, Mississippi									

APPLICATIONS:

General purpose use on pumps, fans, blowers, compressors, conveyors, material handling and other industrial machinery installed in damp, dusty or dirty environments.