



PEXP213TC-7.5-2

EXPLOSION PROOF ELECTRIC MOTOR

NEMA PREMIUM EFFICIENCY

TOTALLY ENCLOSED FAN COOLED; EXPLOSION PROOF ENCLOSURE - C-FLANGE WITH FEET

CLASS I DIVISION I GROUP C & D; CLASS II DIVISION I GROUP F & G

T3C, with Ambient Temperature Rating: -20 ° C to 55 ° C @ 1.15 SF

T3C, with Ambient Temperature Rating: -20° C to 40° C @ 1.0 SF for Inverter Duty

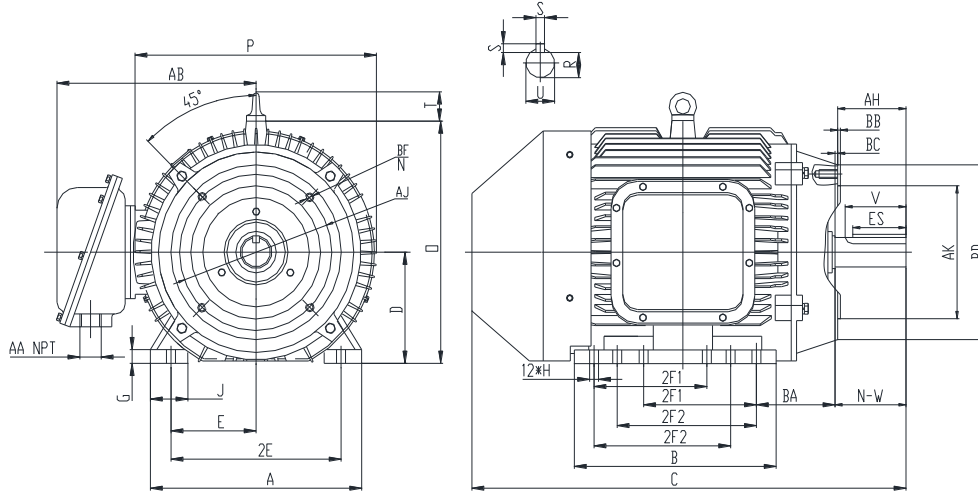

DIMENSIONS

HP	RPM	Frame	MOUNTING														
			A	B	C	D	G	H	J	E	2E	2F1	2F2	O	P	T	BA
7.5	3600	213TC	10.43	10.08	21.85	5.25	0.87	0.41	2.16	4.25	8.5	5.5	7	11.4	12.56	2.04	3.5

FLANGE							Shaft Extension, Key Set					
AH	AJ	AK	BB	BC	BD	BF	U	V	R	S	ES	N-W
3.12	7.25	8.5	0.25	0.25	9	4*1/2-13	1.375	3.12	1.201	0.312	2.41	3.38

Conduit Box		Bearings		Mount
AA	AB	DE	ODE	
1	11.37	6308-ZZ	6308-ZZ	F1

BEARING LUBRICATION: The bearings come lubricated with Mobil Polyrex EM Polyurea Grease.





PEXP213TC-7.5-2

EXPLOSION PROOF ELECTRIC MOTOR

NEMA PREMIUM EFFICIENCY

TOTALLY ENCLOSED FAN COOLED; EXPLOSION PROOF ENCLOSURE - C-FLANGE WITH FEET

CLASS I DIVISION I GROUP C & D; CLASS II DIVISION I GROUP F & G

T3C, with Ambient Temperature Rating: -20 ° C to 55 ° C @ 1.15 SF





T3C, with Ambient Temperature Rating: -20° C to 40° C @ 1.0 SF for Inverter Duty

PERFORMANCE DATA

HP	RPM	Frame	Voltage	Frequency (Hz)	Full Load S.F.	Insulation Class	NEMA Design	Slip (%)	NEMA Code	Enclosure Type	IP Rating	Max. Ambient	Oper Temp Code	Max. KVAR
7.5	3540	213TC	208-230/460	60	1.15	F	B	1.7	H	TEXP	55	40 °C	T3C	1.8

Amps (460V)		Max. Amps (208V)	Efficiency (%)			Power Factor			Torque (ft-lb)			DE Bearing	ODE Bearing	Connection	Weight (lbs.)
FLA	LRA	60Hz	100%	75%	50%	100%	75%	50%	FLT	LRT %	BDT %				
8.3	63.5	18.36	89.5	90.0	85.0	0.86	0.90	0.85	11.17	140	200	6308-ZZ	6308-ZZ	9 Lead 2Δ/Δ	253

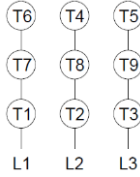
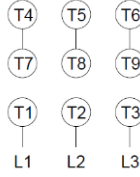
NAME PLATE

		AC INDUCTION MOTOR PREMIUM EFFICIENCY EXPLOSION-PROOF						CONNECTION DIAGRAMS								
CAT. NO.		PEXP213TC-7.5-2		FRAME 213TC		RATING CONT		PHASE 3								
DE BRG.		6308-ZZ		ODE BRG.		6308-ZZ		LUB. Mobil Polyrex EM								
MAX. AMB.		40 °C		INS. CLASS		F		CONN.		9 Lead 2Δ/Δ	SER.	208-230V 				
USABLE ON 208V 60HZ AT		18.4		MAX AMPS		ENCL		TEXP		WEIGHT	253					
60 HERTZ DATA		HP 7.5		RPM 3540		HP 7.5		RPM 2950		50 HERTZ DATA						
		VOLTS 208-230/460				VOLTS 190/380										
		F.L. AMPS 18.4 - 16.6 / 8.3				F.L. AMPS 20.1/10.1										
		S.F. AMPS 9.55				S.F. AMPS 20.1/10.1										
		S.F. 1.15		DESIGN B		CODE H		S.F. 1.0					DESIGN B		CODE J	
		NEMA NOM.EFF 89.5		NOM. P.F. 0.86		NEMA NOM.EFF 89.2		NOM. P.F. 0.86								
NEMA MIN.EFF 87.5		MAX. KVAR 1.8		NEMA MIN.EFF 87.0				460V 								
General purpose use on industrial machinery installed in damp, dusty or dirty environments. These motors are designed for use in hazardous locations defined by class and group.				 CC041B												
Hernando, MS 38632																



PEXP213TC-7.5-2

EXPLOSION PROOF ELECTRIC MOTOR

NEMA PREMIUM EFFICIENCY

TOTALLY ENCLOSED FAN COOLED; EXPLOSION PROOF ENCLOSURE - C-FLANGE WITH FEET

CLASS I DIVISION I GROUP C & D; CLASS II DIVISION I GROUP F & G

T3C, with Ambient Temperature Rating: -20 ° C to 55 ° C @ 1.15 SF

T3C, with Ambient Temperature Rating: -20° C to 40° C @ 1.0 SF for Inverter Duty

UL NAME PLATE

 LISTED E310089	ELECTRIC MOTOR FOR HAZARDOUS LOCATIONS			NO.XXXXXX
	Classes and Groups	Temp. code	Max. Amb.	Frame
	CLASS I DIVISION 1 GROUP C D,	T3C	40°C, 55°C	140/180/210
	CLASS II DIVISION 1 GROUP F G,	T3C	40°C	250~449
	CLASS I DIVISION 1 GROUP C D.	T2B	55°C	250~449
Inverter Rated				
PWM - Constant Torque - 12 to 60 Hertz, Variable Torque - 6 to 60 Hertz when the input to the PWM is 480V/60Hz;				
PWM - Constant Torque - 10 to 50 Hertz, Variable Torque - 5 to 50 Hertz, when the input to the PWM is 380V/50Hz.				
NEMA MG1-Part 31				8AP.866.1102

APPLICATIONS:

General purpose use on pumps, fans, blowers, compressors, conveyors, material handling and other industrial machinery installed in damp, dusty or dirty environments. These motors are designed to be used in hazardous locations as defined by class and group.