



## PEXP213TC-7.5-4

**EXPLOSION PROOF ELECTRIC MOTOR**

**NEMA PREMIUM EFFICIENCY**

**TOTALLY ENCLOSED FAN COOLED; EXPLOSION PROOF ENCLOSURE - C-FLANGE WITH FEET**

**CLASS I DIVISION I GROUP C & D; CLASS II DIVISION I GROUP F & G**

**T3C, with Ambient Temperature Rating: -20 ° C to 55 ° C @ 1.15 SF**

**T3C, with Ambient Temperature Rating: -20° C to 40° C @ 1.0 SF for Inverter Duty**

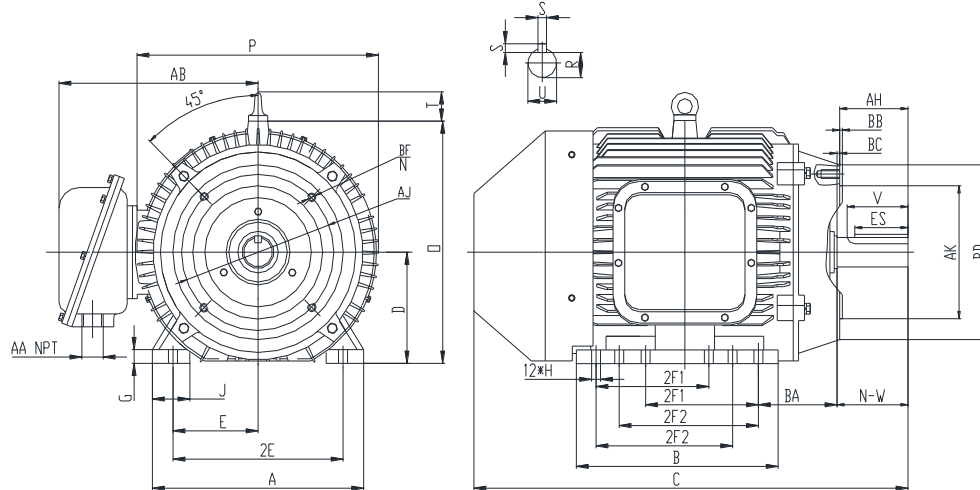

### DIMENSIONS

HP	RPM	Frame	MOUNTING														
			A	B	C	D	G	H	J	E	2E	2F1	2F2	O	P	T	BA
7.5	1800	213TC	10.43	10.08	21.85	5.25	0.87	0.41	2.16	4.25	8.5	5.5	7	11.4	12.56	2.04	3.5

FLANGE							Shaft Extension, Key Set					
AH	AJ	AK	BB	BC	BD	BF	U	V	R	S	ES	N-W
3.12	7.25	8.5	0.25	0.25	9	4*1/2-13	1.375	3.12	1.201	0.312	2.41	3.38

Conduit Box		Bearings		Mount
AA	AB	DE	ODE	
1	11.37	6308-ZZ	6308-ZZ	F1

**BEARING LUBRICATION:** The bearings come lubricated with Mobil Polyrex EM Polyurea Grease.





## PEXP213TC-7.5-4

**EXPLOSION PROOF ELECTRIC MOTOR**

**NEMA PREMIUM EFFICIENCY**

**TOTALLY ENCLOSED FAN COOLED; EXPLOSION PROOF ENCLOSURE - C-FLANGE WITH FEET**

**CLASS I DIVISION I GROUP C & D; CLASS II DIVISION I GROUP F & G**

**T3C, with Ambient Temperature Rating: -20 ° C to 55 ° C @ 1.15 SF**

**T3C, with Ambient Temperature Rating: -20° C to 40° C @ 1.0 SF for Inverter Duty**





### PERFORMANCE DATA

HP	RPM	Frame	Voltage	Frequency (Hz)	Full Load S.F.	Insulation Class	NEMA Design	Slip (%)	NEMA Code	Enclosure Type	IP Rating	Max. Ambient	Oper Temp Code	Max. KVAR
7.5	1770	213TC	208-230/460	60	1.15	F	B	1.7	H	TEXP	55	40 °C	T3C	3.0

Amps (460V)		Max. Amps (208V)	Efficiency (%)			Power Factor			Torque (ft-lb)			DE Bearing	ODE Bearing	Connection	Weight (lbs.)
FLA	LRA	60Hz	100%	75%	50%	100%	75%	50%	FLT	LRT %	BDT %				
8.9	63.5	19.68	91.7	91.5	89.0	0.84	0.82	0.74	22.3	175	215	6308-ZZ	6308-ZZ	9 Lead 2Δ/Δ	254

### NAME PLATE

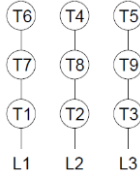
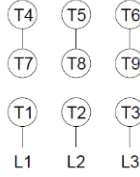
		<b>AC INDUCTION MOTOR</b> PREMIUM EFFICIENCY EXPLOSION-PROOF						CONNECTION DIAGRAMS											
CAT. NO.		PEXP213TC-7.5-4		FRAME 213TC		RATING CONT		PHASE 3											
DE BRG.		6308-ZZ		ODE BRG.		6308-ZZ		LUB. Mobil Polyrex EM											
MAX. AMB.		40 °C		INS. CLASS		F		CONN.		9 Lead 2Δ/Δ	SER.	208-230V 							
USABLE ON 208V 60HZ AT		19.7		MAX AMPS		ENCL		TEXP		WEIGHT	254								
60 HERTZ DATA		HP 7.5		RPM 1770		HP 7.5		RPM 1475		50 HERTZ DATA			460V 						
		VOLTS 208-230/460				VOLTS 190/380													
		F.L. AMPS 19.7 - 17.8 / 8.9				F.L. AMPS 21.5/10.8													
		S.F. AMPS 10.24				S.F. AMPS 21.5/10.8													
		S.F. 1.15		DESIGN B		CODE H		S.F. 1.0								DESIGN B		CODE J	
		NEMA NOM.EFF 91.7		NOM. P.F. 0.84		NEMA NOM.EFF 89.6		NOM. P.F. 0.84											
NEMA MIN.EFF 90.2		MAX. KVAR 3.0		NEMA MIN.EFF 87.5															
General purpose use on industrial machinery installed in damp, dusty or dirty environments. These motors are designed for use in hazardous locations defined by class and group. Hernando, MS 38632				 CC041B															



**PEXP213TC-7.5-4**

**EXPLOSION PROOF ELECTRIC MOTOR**

**NEMA PREMIUM EFFICIENCY**

**TOTALLY ENCLOSED FAN COOLED; EXPLOSION PROOF ENCLOSURE - C-FLANGE WITH FEET**

**CLASS I DIVISION I GROUP C & D; CLASS II DIVISION I GROUP F & G**

**T3C, with Ambient Temperature Rating: -20 ° C to 55 ° C @ 1.15 SF**

**T3C, with Ambient Temperature Rating: -20° C to 40° C @ 1.0 SF for Inverter Duty**

**UL NAME PLATE**

 LISTED E310089		NO. XXXXXX ELECTRIC MOTOR FOR HAZARDOUS LOCATIONS	
Classes and Groups	Temp. code	Max. Amb.	Frame
CLASS I DIVISION 1 GROUP C D,	T3C	40°C, 55°C	140/180/210
CLASS II DIVISION 1 GROUP F G.	T3C	40°C	250~449
CLASS I DIVISION 1 GROUP C D.	T2B	55°C	250~449
Inverter Rated			
PWM - Constant Torque - 12 to 60 Hertz, Variable Torque - 6 to 60 Hertz when the input to the PWM is 480V/60Hz;			
PWM - Constant Torque - 10 to 50 Hertz, Variable Torque - 5 to 50 Hertz, when the input to the PWM is 380V/50Hz.			
NEMA MG1-Part 31		8AP.866.1102	

**APPLICATIONS:**

General purpose use on pumps, fans, blowers, compressors, conveyors, material handling and other industrial machinery installed in damp, dusty or dirty environments. These motors are designed to be used in hazardous locations as defined by class and group.