



PEXP324TC-40-4

EXPLOSION PROOF ELECTRIC MOTOR

NEMA PREMIUM EFFICIENCY

TOTALLY ENCLOSED FAN COOLED; EXPLOSION PROOF ENCLOSURE - C-FLANGE WITH FEET

CLASS I DIVISION I GROUP C & D; CLASS II DIVISION I GROUP F & G

T3C, with Ambient Temperature Rating: -20° C to 40° C @ 1.15 SF, or 1.0 SF for Inverter Duty

CLASS I DIVISION I GROUP C & D

T2B, with Ambient Temperature Rating: -20° C to 55° C @ 1.15 SF, or 1.0 SF for Inverter Duty

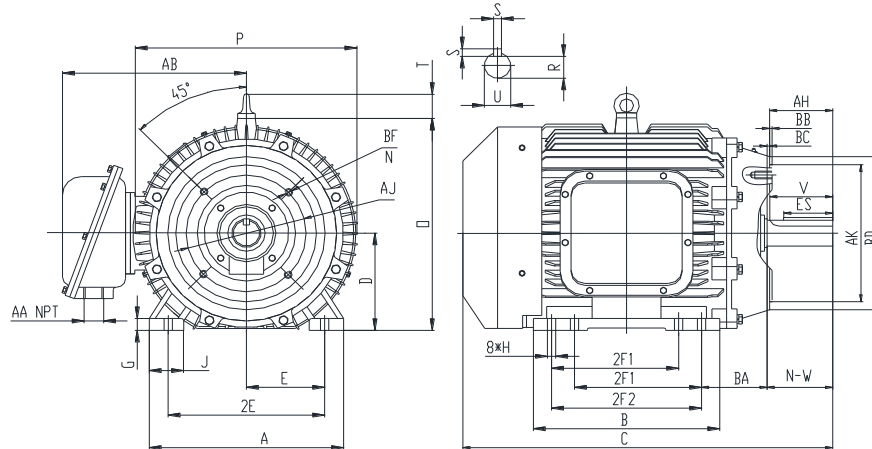

DIMENSIONS

HP	RPM	Frame	MOUNTING														
			A	B	C	D	G	H	J	E	2E	2F1	2F2	O	P	T	BA
40	1800	324TC	15.5	15	31.75	8	1	0.66	2.75	6.25	12.5	10.5	12	17.45	18.34	3	5.25

FLANGE							Shaft Extension, Key Set						
AH	AJ	AK	BB	BC	BD	BF	U	V	R	S	ES	N-W	
5	11	12.5	0.25	0.25	14	4*5/8-11	2.125	5	1.845	0.5	3.91	5.25	

Conduit Box		Bearings		Mount
AA	AB	DE	ODE	
2	15.2	6312/C3	6312/C3	F1

BEARING LUBRICATION: The bearings come lubricated with Mobil Polyrex EM Polyurea Grease. It is recommended that you add some additional lubrication when the motor is installed.

Three options (brands) for suitable lubrication include, but are not limited to, the following:

- 1.) Mobil Polyrex EM
- 2.) Citco Polyurea MP
- 3.) Conoco Phillips Polytac EP





PEXP324TC-40-4

EXPLOSION PROOF ELECTRIC MOTOR

NEMA PREMIUM EFFICIENCY

TOTALLY ENCLOSED FAN COOLED; EXPLOSION PROOF ENCLOSURE - C-FLANGE WITH FEET

CLASS I DIVISION I GROUP C & D; CLASS II DIVISION I GROUP F & G

T3C, with Ambient Temperature Rating: -20° C to 40° C @ 1.15 SF, or 1.0 SF for Inverter Duty

CLASS I DIVISION I GROUP C & D



T2B, with Ambient Temperature Rating: -20° C to 55° C @ 1.15 SF, or 1.0 SF for Inverter Duty

PERFORMANCE DATA

HP	RPM	Frame	Voltage	Frequency (Hz)	Full Load S.F.	Insulation Class	NEMA Design	Slip (%)	NEMA Code	Enclosure Type	IP Rating	Max. Ambient	Oper Temp Code	Max. KVAR
40	1780	324TC	208-230/460	60	1.15	F	B	1.1	G	TEXP	55	40 °C	T3C	11.2

Amps (460V)		Max. Amps (208V)	Efficiency (%)			Power Factor			Torque (ft-lb)			DE Bearing	ODE Bearing	Connection	Weight (lbs.)
FLA	LRA	60Hz	100%	75%	50%	100%	75%	50%	FLT	LRT %	BDT %				
44.5	290	98.41	94.1	94.2	93.9	0.85	0.84	0.78	117.8	140	200	6312/C3	6312/C3	9 Lead 2Δ/Δ	734

NAME PLATE

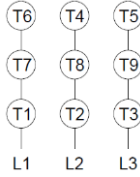
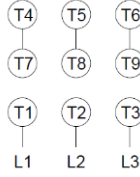
		AC INDUCTION MOTOR PREMIUM EFFICIENCY EXPLOSION-PROOF						CONNECTION DIAGRAMS				
CAT. NO. PEXP324TC-40-4		FRAME 324TC		RATING CONT		PHASE 3						
DE BRG. 6312/C3		ODE BRG. 6312/C3		LUB. Mobil Polyrex EM								
MAX. AMB. 40 °C		INS. CLASS F		CONN. 9 Lead 2Δ/Δ		SER.						
USABLE ON 208V 60HZ AT 98.4 MAX AMPS		ENCL TEXP		WEIGHT 734								
60 HERTZ DATA	HP 40		RPM 1780		HP 40		RPM 1483					
	VOLTS 208-230/460				VOLTS 190/380							
	F.L. AMPS 98.4 - 89 / 44.5				F.L. AMPS 107.7/53.9							
	S.F. AMPS 51.18				S.F. AMPS 107.7/53.9							
	S.F. 1.15		DESIGN B		CODE G		S.F. 1.0		DESIGN B		CODE H	
	NEMA NOM.EFF 94.1		NOM. P.F. 0.85		NEMA NOM.EFF 93.5		NOM. P.F. 0.85					
NEMA MIN.EFF 93.0		MAX. KVAR 11.2		NEMA MIN.EFF 92.2								
General purpose use on industrial machinery installed in damp, dusty or dirty environments. These motors are designed for use in hazardous locations defined by class and group. Hernando, MS 38632				 CC041B				208-230V 				
								460V 				



PEXP324TC-40-4

EXPLOSION PROOF ELECTRIC MOTOR

NEMA PREMIUM EFFICIENCY

TOTALLY ENCLOSED FAN COOLED; EXPLOSION PROOF ENCLOSURE - C-FLANGE WITH FEET

CLASS I DIVISION I GROUP C & D; CLASS II DIVISION I GROUP F & G

T3C, with Ambient Temperature Rating: -20° C to 40° C @ 1.15 SF, or 1.0 SF for Inverter Duty

CLASS I DIVISION I GROUP C & D

T2B, with Ambient Temperature Rating: -20° C to 55° C @ 1.15 SF, or 1.0 SF for Inverter Duty

UL NAME PLATE

 LISTED E310089	ELECTRIC MOTOR FOR HAZARDOUS LOCATIONS			NO. XXXXXX
	Classes and Groups	Temp. code	Max. Amb.	Frame
	CLASS I DIVISION 1 GROUP C D,	T3C	40°C, 55°C	140/180/210
	CLASS II DIVISION 1 GROUP F G,	T3C	40°C	250~449
	CLASS I DIVISION 1 GROUP C D.	T2B	55°C	250~449
Inverter Rated				
PWM - Constant Torque - 12 to 60 Hertz, Variable Torque - 6 to 60 Hertz when the input to the PWM is 480V/60Hz;				
PWM - Constant Torque - 10 to 50 Hertz, Variable Torque - 5 to 50 Hertz, when the input to the PWM is 380V/50Hz.				
NEMA MG1-Part 31				8AP.866.1102

APPLICATIONS:

General purpose use on pumps, fans, blowers, compressors, conveyors, material handling and other industrial machinery installed in damp, dusty or dirty environments. These motors are designed to be used in hazardous locations as defined by class and group.