

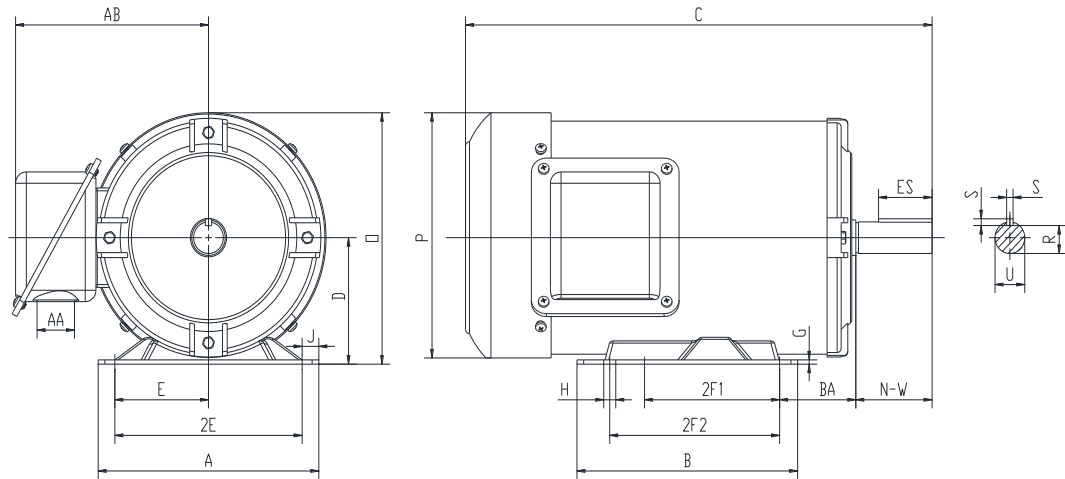

PR145T2M2A

GENERAL PURPOSE ELECTRIC MOTOR
NEMA PREMIUM EFFICIENCY
ROLLED STEEL CONSTRUCTION
TOTALLY ENCLOSED FAN COOLED
INVERTER RATED (10:1 VT; 5:1 CT)



DIMENSIONS

HP	RPM	Frame	MOUNTING														
			A	B	C	D	G	H	J	E	2E	2F1	2F2	O	P	T	BA
2	3600	145T	6.5	6.5	11.5	3.5	0.12	0.34	0.5	2.75	5.5	4	5	7	6.8	NA	2.25

Shaft Extension, Key Set						Conduit Box		Bearings		Mount
U	V	R	S	ES	N-W	AA	AB	DE	ODE	
0.875	NA	0.771	0.188	1.41	2.25	1.1	6	6205-2RZC3	6203-2RZC3	F1

BEARING LUBRICATION: The bearings come lubricated with Mobil Polyrex EM Polyurea Grease.





PR145T2M2A







GENERAL PURPOSE ELECTRIC MOTOR
NEMA PREMIUM EFFICIENCY
ROLLED STEEL CONSTRUCTION
TOTALLY ENCLOSED FAN COOLED
INVERTER RATED (10:1 VT; 5:1 CT)

PERFORMANCE DATA

HP	RPM	Frame	Voltage	Frequency (Hz)	Full Load S.F.	Insulation Class	NEMA Design	Slip (%)	NEMA Code	Enclosure Type	IP Rating	Max. Ambient
2	3500	145T	208-230/460	60	1.15	F	B	2.8	M	TEFC	55	40 °C

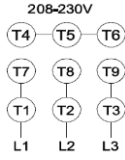
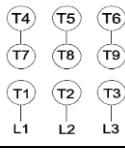
Amps (460V)		Efficiency (%)			Power Factor			Torque (ft-lb)			DE Bearing	ODE Bearing	Connection	Weight (lbs.)
FLA	LRA	100%	75%	50%	100%	75%	50%	FLT	LRT %	BDT %	6205-2RZC3	6203-2RZC3	9 Lead 2Y/Y	33
2.5	21.2	85.5	86.2	84.0	0.87	0.82	0.74	3.03	388	419				

NAME PLATE

		THREE PHASE AC INDUCTION MOTOR							
CAT NO:	PR145T2M2A	FRAME	145T	PH	3				
HZ	60	S.F.	1.15	ENCL	TEFC			IP	55
HP	2	RPM	3500	DUTY	CONT			DES	B
VOLT	208-230/460	AMB	40 °C	INS	F				
FLA	5.4-5/2.5	DE BRG	6205-2RZC3						
CODE	M	P.F.	0.87	ODE BRG	6203-2RZC3				
EFF	85.5	MIN	82.5	LBS	33				
CONNECTION	9 Lead 2Y/Y	SER NO.							
Hernando, MS www.naemotors.com					CC340B				

APPLICATIONS:

General purpose use on pumps, fans, blowers, compressors, conveyors, material handling and other industrial machinery installed in damp, dusty or dirty environments.