

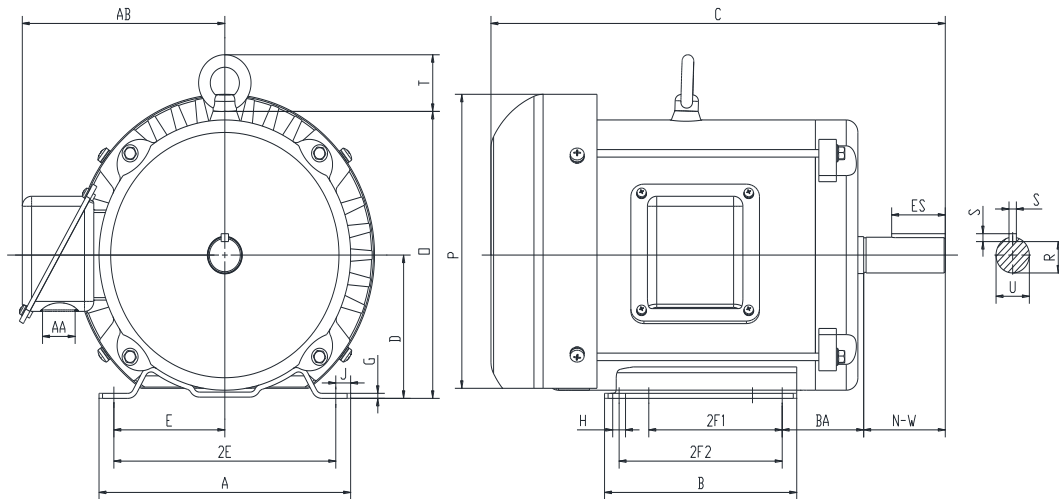

PR213T7.5M2A

GENERAL PURPOSE ELECTRIC MOTOR
NEMA PREMIUM EFFICIENCY
ROLLED STEEL CONSTRUCTION
TOTALLY ENCLOSED FAN COOLED
INVERTER RATED (10:1 VT; 5:1 CT)



DIMENSIONS

HP	RPM	Frame	MOUNTING														
			A	B	C	D	G	H	J	E	2E	2F1	2F2	O	P	T	BA
7.5	3600	213T	10.4	8.5	19	5.25	0.16	0.41	0.95	4.25	8.5	5.5	7	10	10.6	1.2	3.5

Shaft Extension, Key Set						Conduit Box		Bearings		Mount
U	V	R	S	ES	N-W	AA	AB	DE	ODE	
1.375	NA	1.201	0.312	2.41	3.38	1.38	8.1	6307-2RZC3	6206-2RZC3	F1

BEARING LUBRICATION: The bearings come lubricated with Mobil Polyrex EM Polyurea Grease.





PR213T7.5M2A







GENERAL PURPOSE ELECTRIC MOTOR
NEMA PREMIUM EFFICIENCY
ROLLED STEEL CONSTRUCTION
TOTALLY ENCLOSED FAN COOLED
INVERTER RATED (10:1 VT; 5:1 CT)

PERFORMANCE DATA

HP	RPM	Frame	Voltage	Frequency (Hz)	Full Load S.F.	Insulation Class	NEMA Design	Slip (%)	NEMA Code	Enclosure Type	IP Rating	Max. Ambient
7.5	3525	213T	208-230/460	60	1.15	F	B	2.1	H	TEFC	55	40 °C

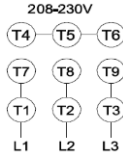
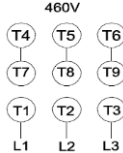
Amps (460V)		Efficiency (%)			Power Factor			Torque (ft-lb)			DE Bearing	ODE Bearing	Connection	Weight (lbs.)
FLA	LRA	100%	75%	50%	100%	75%	50%	FLT	LRT %	BDT %				
9.1	60.5	89.6	89.5	87.9	0.87	0.84	0.77	11.24	193	248	6307-2RZC3	6206-2RZC3	9 Lead 2Y/Y	122

NAME PLATE

		THREE PHASE AC INDUCTION MOTOR					
CAT NO:	PR213T7.5M2A	FRAME	213T	PH	3		
HZ	60	S.F.	1.15	ENCL	TEFC	IP	55
HP	7.5	RPM	3525	DUTY	CONT	DES	B
VOLT	208-230/460	AMB	40 °C	INS	F		
FLA	19.6-18.2/9.1	DE BRG				6307-2RZC3	
CODE	H	P.F.	0.87	ODE BRG		6206-2RZC3	
EFF	89.6	MIN	87.5	LBS		122	
CONNECTION	9 Lead 2Y/Y	SER NO.					
Hernando, MS www.naemotors.com					CC340B		

APPLICATIONS:

General purpose use on pumps, fans, blowers, compressors, conveyors, material handling and other industrial machinery installed in damp, dusty or dirty environments.