

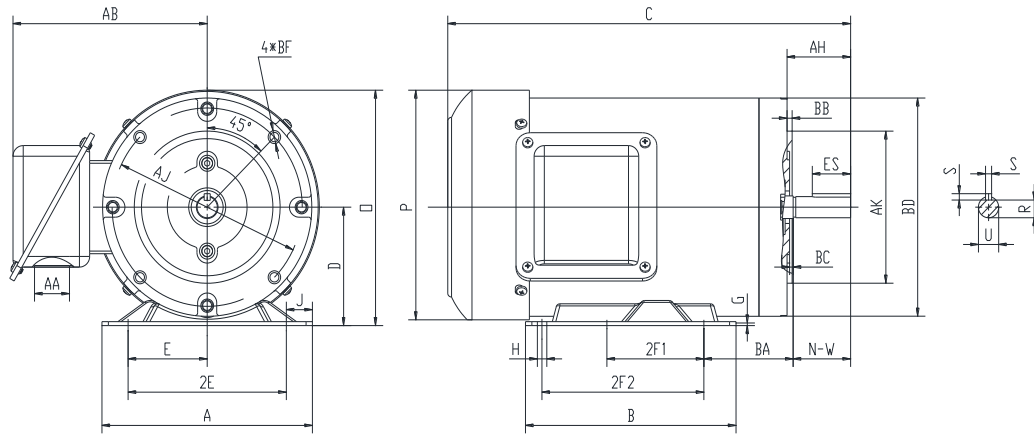

PR56C1.5M4A

GENERAL PURPOSE ELECTRIC MOTOR
NEMA PREMIUM EFFICIENCY
ROLLED STEEL CONSTRUCTION
TOTALLY ENCLOSED FAN COOLED
INVERTER RATED (10:1 VT; 5:1 CT)



DIMENSIONS

HP	RPM	Frame	MOUNTING														
			A	B	C	D	G	H	J	E	2E	2F1	2F2	O	P	T	BA
1.5	1800	56C	6.3	4	12.5	3.5	0.12	0.34	0.71	2.44	4.88	3	NA	7	6.8	NA	2.75

FLANGE							Shaft Extension, Key Set						
AH	AJ	AK	BB	BC	BD	BF	U	V	R	S	ES	N-W	
2.06	5.875	4.5	0.16	0.19	6.46	4*3/8-16	0.625	NA	0.517	0.188	1.41	1.88	

Conduit Box		Bearings		Mount
AA	AB	DE	ODE	
1.1	6	6203-2RZC3	6203-2RZC3	F1

BEARING LUBRICATION: The bearings come lubricated with Mobil Polyrex EM Polyurea Grease.





PR56C1.5M4A

GENERAL PURPOSE ELECTRIC MOTOR
NEMA PREMIUM EFFICIENCY
ROLLED STEEL CONSTRUCTION
TOTALLY ENCLOSED FAN COOLED
INVERTER RATED (10:1 VT; 5:1 CT)







PERFORMANCE DATA

HP	RPM	Frame	Voltage	Frequency (Hz)	Full Load S.F.	Insulation Class	NEMA Design	Slip (%)	NEMA Code	Enclosure Type	IP Rating	Max. Ambient
1.5	1750	56C	230/460	60	1.15	F	B	2.8	M	TEFC	55	40 °C

Amps (460V)		Efficiency (%)			Power Factor			Torque (ft-lb)			DE Bearing	ODE Bearing	Connection	Weight (lbs.)
FLA	LRA	100%	75%	50%	100%	75%	50%	FLT	LRT %	BDT %				
2.2	15.5	86.5	87.4	84.8	0.76	0.68	0.56	4.53	324	433	6203-2RZC3	6203-2RZC3	9 Lead 2Y/Y	36

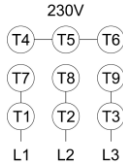
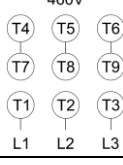
*Usable at 208 Volts

NAME PLATE

		THREE PHASE AC INDUCTION MOTOR					
CAT NO:	PR56C1.5M4A	FRAME	56C	PH	3	230V 	
HZ	60	S.F.	1.15	ENCL	TEFC	IP	55
HP	1.5	RPM	1750	DUTY	CONT	DES	B
VOLT	230/460	AMB	40 °C	INS	F	460V 	
FLA	4.4/2.2	DE BRG	6203-2RZC3				
CODE	M	P.F.	0.76	ODE BRG	6203-2RZC3		
EFF	86.5	MIN	84.0	LBS	36		
CONNECTION	9 Lead 2Y/Y	SER NO.					
Hernando, MS www.naemotors.com					CC340B		

APPLICATIONS:

General purpose use on pumps, fans, blowers, compressors, conveyors, material handling and other industrial machinery installed in damp, dusty or dirty environments.