



SS56C1/2M-4-RB

WASHDOWN DUTY MOTOR

HIGH EFFICIENCY / EISA COMPLIANT

STAINLESS STEEL CONSTRUCTION - ROUND BODY (C-FLANGE FOOTLESS)

TOTALLY ENCLOSED FAN COOLED - IP66 CONSTRUCTION

INVERTER DUTY 10:1 CT; 20:1 VT - NEMA MG1 PART 31

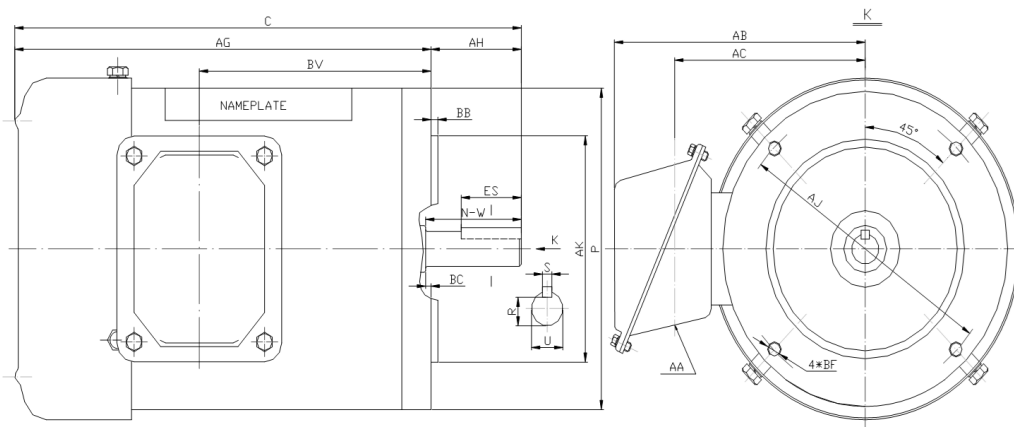

DIMENSIONS

HP	RPM	Frame	MOUNTING									
			C	P	AH	AJ	AK	AG	BA	BB	BC	BF
1/2	1800	56C	11.59	6.5	2.06	5.875	4.5	9.53	N/A	0.16	-0.19	4*3/8-16

Shaft Extension, Key Set					Conduit Box			
U	R	S	ES	N-W	AA	AB	AC	BV
0.625	0.517	0.188	1.41	1.88	0.86	5.75	4.25	5.3

Bearings		Mount
DE	ODE	
6205-2RS	6205-2RS	F1

BEARING LUBRICATIONS: The sealed bearings come lubricated with NEVASTANE XS 80 Grease which complies with FDA Chapter 21 CFR 178.3570





SS56C1/2M-4-RB

WASHDOWN DUTY MOTOR

HIGH EFFICIENCY / EISA COMPLIANT

STAINLESS STEEL CONSTRUCTION - ROUND BODY (C-FLANGE FOOTLESS)

TOTALLY ENCLOSED FAN COOLED - IP66 CONSTRUCTION

INVERTER DUTY 10:1 CT; 20:1 VT - NEMA MG1 PART 31

PERFORMANCE DATA

HP	RPM	Frame	Voltage	Frequency (Hz)	Full Load S.F.	Insulation Class	NEMA Design	Slip (%)	NEMA Code	Enclosure Type	IP Rating	Max. Ambient
1/2	1745	56C	208-230/460	60	1.15	F	B	3.1	K	TEFC	66	40 °C

Amps (460V)		Efficiency (%)			Power Factor			Torque (ft-lb)			DE Bearing	ODE Bearing	Connection	Weight (lbs.)
FLA	LRA	100%	75%	50%	100%	75%	50%	FLT	LRT %	BDT %				
0.8	10	82.5	77.0	72.0	0.78	0.62	0.53	1.5	285	300	6205-2RS	6205-2RS	9 Lead 2Y/Y	29

NAME PLATE

		THREE PHASE AC INDUCTION MOTOR INVERTER DUTY 20:1 VT; 10:1 CT								Hernando, MS 38632			
		Model : SS56C1/2M-4-RB				IP 66		FRAME 56C		LB/WT 29			
HZ 60		S.F. 1.15		HZ 50		S.F. 1.0		NEMA DESIGN B					
HP 1/2		RPM 1745		HP 1/2		RPM 1450		ENCL. TEFC		INS F			
VOLTS 208-230/460				VOLTS 190/380				DUTY CONT		AMB 40 °C			
AMPS 1.8 - 1.6 / 0.8				AMPS 1.8/0.9				DE BRG 6205-2RS					
CODE K		P.F. 0.78		CODE K		P.F. 0.80		ODE BRG 6205-2RS					
EFF 82.5		MIN 80.0		EFF 80.0		MIN 77.0		SER NO.					
<div style="display: flex; justify-content: space-around;"> <div style="text-align: center;"> <p>208-230V</p> </div> <div style="text-align: center;"> <p>460V</p> </div> </div>												CC082A	
MADE IN CHINA													

Factory Certified for T2B
 Div 2. Class I, Gr. A , B , C & D
 and Class II, Gr. F & G

APPLICATIONS:

Applications include washdown applications, food processing, chemical processing, pharmaceuticals, poultry processing, meat processing, dairy applications, bakeries, snack foods, bottling and extremely corrosive environments.