



V2-10D4-W21510A

VERTICAL HOLLOW SHAFT MOTOR

NEMA PREMIUM EFFICIENCY

INVERTER DUTY 20:1 VT

INCLUDES INSULATED BEARING MOUNT - 40 HP AND ABOVE

HIGH THRUST DESIGN

THREE PHASE, OPEN DRIP PROOF (WP1) ENCLOSURE

NON-REVERSE BALL TYPE RATCHET

COUPLING INCLUDED

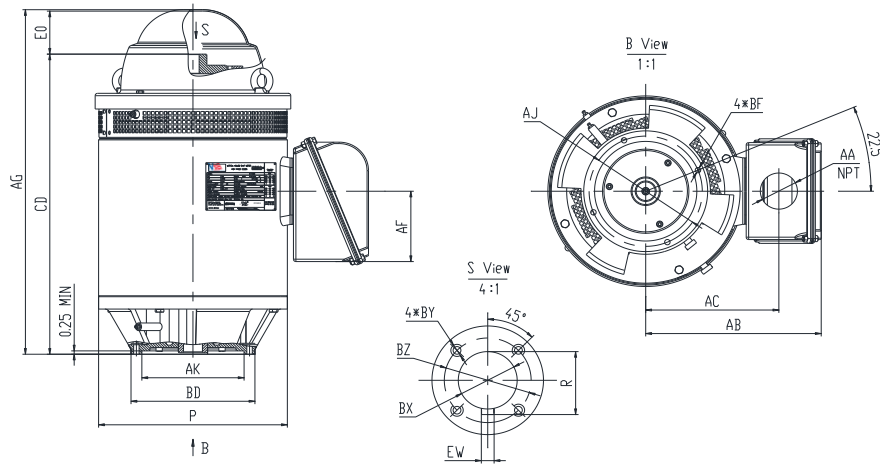

DIMENSIONS

HP	RPM	Frame	MOUNTING DIMENSIONS													
			BD	AJ	AK	BF	BX	BZ	EW	R	BY	CD	E0 >	AC	AA	AF
10	1780	215TP	10	9.125	8.25	0.44	1	1.38	0.25	1.114	10-32	17.56	4.03	10.6	1	5.83

OVERALL DIMENSIONS			BEARINGS	
P	AB	AG	UPPER	LOWER
15.24	14.17	21.79	6210	7310B

COUPLING: Motor comes with a 1.0" coupling. You may select a different size coupling at no extra charge.

BEARING LUBRICATION: The bearings comes lubricated with Mobil Polyrex EM Polyurea Grease.

STEADY BUSHING: Motor is designed to accept a steady bushing. The bore size is 1 inches.





V2-10D4-W21510A





VERTICAL HOLLOW SHAFT MOTOR
NEMA PREMIUM EFFICIENCY
INVERTER DUTY 20:1 VT
INCLUDES INSULATED BEARING MOUNT - 40 HP AND ABOVE
HIGH THRUST DESIGN
THREE PHASE, OPEN DRIP PROOF (WP1) ENCLOSURE
NON-REVERSE BALL TYPE RATCHET
COUPLING INCLUDED

PERFORMANCE DATA

HP	RPM	Frame	Voltage	Frequency (Hz)	Full Load S.F.	Insulation Class	NEMA Design	Slip (%)	NEMA Code	Enclosure Type	IP Rating	Max. Ambient	Rating CONT
10	1780	215TP	230/460	60	1.15	F	B	1.11	H	WP1	23	40° C	S1

Amps (460V)		Efficiency (%)				Power Factor			Torque (ft-lb)			Down Thrust (lbs.)	Radial Ball Bearing	Angular Contact Bearing	Connection	Weight (lbs.)
FLA	LRA	100%	75%	50%	Min.	100%	75%	50%	FLT	LRT %	BDT %	2500	UPPER	LOWER	12 Lead 2Δ/Δ	366
12.2	85	91.7	91.8	90.2	90.2	0.84	0.79	0.70	29	220	250		6210	7310B		

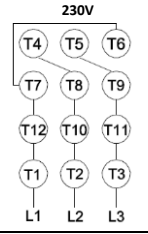
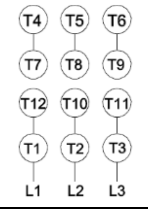
NAME PLATE

 VERTICAL HOLLOW SHAFT HIGH THRUST DESIGN 							CONNECTION DIAGRAMS			
MODEL V2-10D4-W21510A				FRAME 215TP						
Hz	60	S.F.	1.15	ENCL	WP1	DESIGN				B
HP	10	RPM	1780	INS	F	PHASE	3			
VOLTS	230/460	FLA	24.4/12.2	MAX.AMBIENT 40° C						
Enclosure	ODP	IP	23	RATING CONTINUOUS						
NEMA CODE	H	P.F.	0.84	MOTOR WEIGHT 366 LBS.						
NOM EFF	91.7	MIN EFF	90.2	CONNECTION 12 Lead 2Δ/Δ						
DOWN THRUST	2500 LBS.		BASE DIAMETER 10 INCHES							
UPPER BEARING	6210		LOWER BEARING 7310B							
LUBRICATION	MOBIL POLYREX EM		LUBRICATION MOBIL POLYREX EM							
NON-REVERSE RATCHET - BALL TYPE			SERIAL NO.							
Specifically designed for use on deep well turbine pump applications. Hernando, Mississippi			 E310089		CC082A		PART WIND START CAPABLE @ 230V			
			ROTATION 							
MOTOR IS SUITABLE FOR INVERTER RATED 20:1 VT										

APPLICATIONS:

Specifically designed for use on deep well turbine pump applications. The coupling is equipped with a non-reverse ratchet, which prevents motor rotation from backspin at shutdown. These motors are built to NEMA standards and have special bearing arrangements to carry heavy thrust loads.