

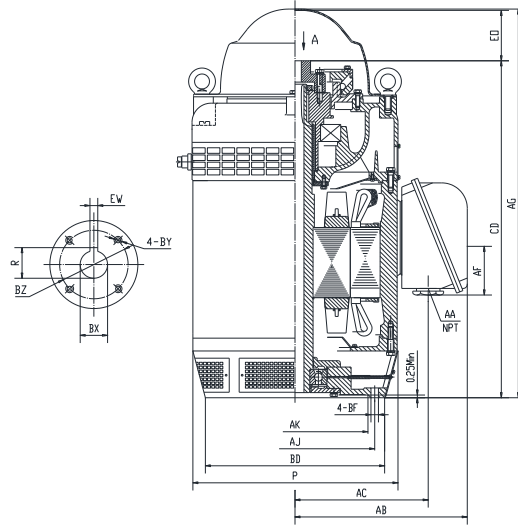

V2-200S4-W44516A-EHT

VERTICAL HOLLOW SHAFT MOTOR
NEMA PREMIUM EFFICIENCY
INVERTER DUTY 20:1 VT
INCLUDES INSULATED BEARING MOUNT - 40 HP AND ABOVE
EXTRA HIGH THRUST DESIGN
THREE PHASE, OPEN DRIP PROOF (WP1) ENCLOSURE
NON-REVERSE BALL TYPE RATCHET
COUPLING INCLUDED



DIMENSIONS

HP	RPM	Frame	MOUNTING DIMENSIONS													
			BD	AJ	AK	BF	BX	BZ	EW	R	BY	CD	E0 >	AC	AA	AF
200	1788	445TP	16.5	14.75	13.5	0.69	1-11/16	2.5	0.375	1.854	1/4-20	44.78	5.4	16.18	3	7.56

OVERALL DIMENSIONS			BEARINGS	
P	AB	AG	UPPER	LOWER
23.3	20.7	50.29	7232B/DT	6318

COUPLING: Motor comes with a 1.69" coupling. You may select a different size coupling at no extra charge.

BEARING LUBRICATION: The lower bearing comes lubricated with Mobil Polyrex EM Polyurea Grease.

OIL RESERVOIR: Motor is shipped without oil. The oil capacity is 5.61 quarts.

STEADY BUSHING: Motor is designed to accept a steady bushing. The bore size is 1-11/16 inches.





V2-200S4-W44516A-EHT







VERTICAL HOLLOW SHAFT MOTOR
NEMA PREMIUM EFFICIENCY
INVERTER DUTY 20:1 VT
INCLUDES INSULATED BEARING MOUNT - 40 HP AND ABOVE
EXTRA HIGH THRUST DESIGN
THREE PHASE, OPEN DRIP PROOF (WP1) ENCLOSURE
NON-REVERSE BALL TYPE RATCHET
COUPLING INCLUDED

PERFORMANCE DATA

HP	RPM	Frame	Voltage	Frequency (Hz)	Full Load S.F.	Insulation Class	NEMA Design	Slip (%)	NEMA Code	Enclosure Type	IP Rating	Max. Ambient	Rating CONT
200	1788	445TP	460	60	1.15	F	B	0.66	G	WP1	23	40° C	S1

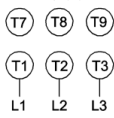
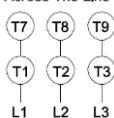
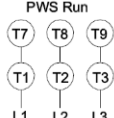
Amps (460V)		Efficiency (%)				Power Factor			Torque (ft-lb)			Down Thrust	Angular Contact Bearing	Radial Ball Bearing	Connection	Weight (lbs.)
FLA	LRA	100%	75%	50%	Min.	100%	75%	50%	FLT	LRT %	BDT %	14400	UPPER	LOWER	6 Lead Δ	2099
221	1462	95.8	94.8	93.7	95.0	0.88	0.88	0.83	584	166	220		7232B/DT	6318		

NAME PLATE

 VERTICAL HOLLOW SHAFT EXTRA HIGH THRUST DESIGN												CONNECTION DIAGRAMS				
MODEL					V2-200S4-W44516A-EHT					FRAME	445TP		PWS Start 			
Hz	60	S.F.	1.15	ENCL	WP1	DESIGN	B		Across The Line 							
HP	200	RPM	1788	INS	F	PHASE	3		PWS Run 							
VOLTS	460	FLA	221	MAX.AMBIENT		40° C										
Enclosure	ODP	IP	23	RATING		CONTINUOUS										
NEMA CODE	G	P.F.	0.88	MOTOR WEIGHT		2099	LBS.									
NOM EFF	95.8	MIN EFF	95.0	CONNECTION		6 Lead Δ										
DOWN THRUST		14400		BASE DIAMETER		16.5	INCHES									
UPPER BEARING		7232B/DT (X 2) EHT		LOWER BEARING		6318										
OIL CAP. UPPER BEARING		5.61	QTS.	LUBRICATION		MOBIL POLYREX EM										
NON-REVERSE RATCHET - BALL TYPE				SERIAL NO.												
Specifically designed for use on deep well turbine pump applications.								CC326B		PART WIND START CAPABLE @ 230V						
Hernando, Mississippi		ROTATION														
MOTOR IS SUITABLE FOR INVERTER RATED 20:1 VT																

APPLICATIONS:

Specifically designed for use on deep well turbine pump applications. The coupling is equipped with a non-reverse ratchet, which prevents motor rotation from backspin at shutdown. These motors are built to NEMA standards and have special bearing arrangements to carry heavy thrust loads.