

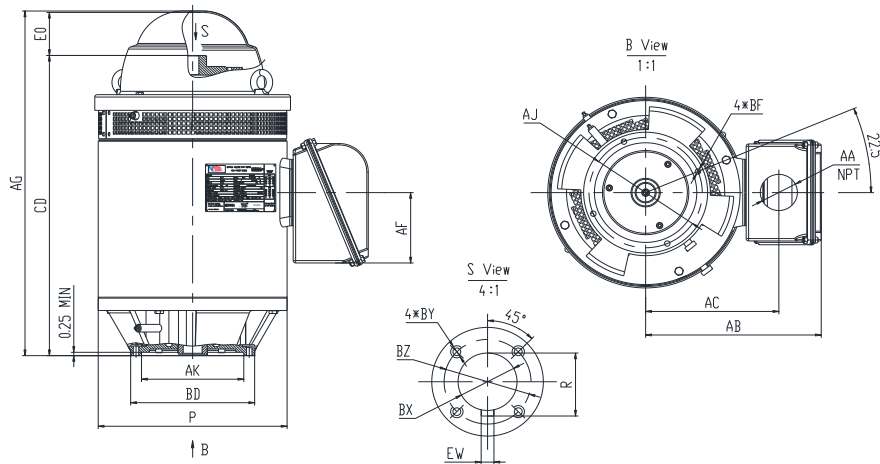

V2-25D4-W28410A

VERTICAL HOLLOW SHAFT MOTOR
NEMA PREMIUM EFFICIENCY
INVERTER DUTY 20:1 VT
INCLUDES INSULATED BEARING MOUNT - 40 HP AND ABOVE
HIGH THRUST DESIGN
THREE PHASE, OPEN DRIP PROOF (WP1) ENCLOSURE
NON-REVERSE BALL TYPE RATCHET
COUPLING INCLUDED



DIMENSIONS

HP	RPM	Frame	MOUNTING DIMENSIONS													
			BD	AJ	AK	BF	BX	BZ	EW	R	BY	CD	EO >	AC	AA	AF
25	1785	284TP	10	9.125	8.25	0.44	1	1.38	0.25	1.114	10-32	24.75	3.22	10.6	3	5.83

OVERALL DIMENSIONS			BEARINGS	
P	AB	AG	UPPER	LOWER
15.24	14.17	28.2	6212	7312B

COUPLING: Motor comes with a 1.0" coupling. You may select a different size coupling at no extra charge.

BEARING LUBRICATION: The bearings comes lubricated with Mobil Polyrex EM Polyurea Grease.

STEADY BUSHING: Motor is designed to accept a steady bushing. The bore size is 1 inches.





V2-25D4-W28410A







VERTICAL HOLLOW SHAFT MOTOR
NEMA PREMIUM EFFICIENCY
INVERTER DUTY 20:1 VT
INCLUDES INSULATED BEARING MOUNT - 40 HP AND ABOVE
HIGH THRUST DESIGN
THREE PHASE, OPEN DRIP PROOF (WP1) ENCLOSURE
NON-REVERSE BALL TYPE RATCHET
COUPLING INCLUDED

PERFORMANCE DATA

HP	RPM	Frame	Voltage	Frequency (Hz)	Full Load S.F.	Insulation Class	NEMA Design	Slip (%)	NEMA Code	Enclosure Type	IP Rating	Max. Ambient	Rating CONT
25	1780	284TP	230/460	60	1.15	F	B	0.96	H	WP1	23	40° C	S1

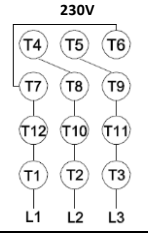
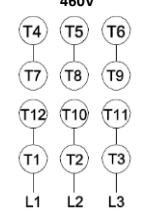
Amps (460V)		Efficiency (%)				Power Factor			Torque (ft-lb)			Down Thrust	Radial Ball Bearing	Angular Contact Bearing	Connection	Weight (lbs.)
FLA	LRA	100%	75%	50%	Min.	100%	75%	50%	FLT	LRT %	BDT %	3200	UPPER	LOWER	12 Lead 2Δ/Δ	554
28.8	222	93.6	93.2	91.9	92.4	0.86	0.82	0.72	72	238	270		6212	7312B		

NAME PLATE

 VERTICAL HOLLOW SHAFT HIGH THRUST DESIGN 							CONNECTION DIAGRAMS		
MODEL V2-25D4-W28410A				FRAME 284TP					
Hz 60	S.F. 1.15	ENCL WP1	DESIGN B						
HP 25	RPM 1780	INS F	PHASE 3						
VOLTS 230/460	FLA 57.6/28.8	MAX.AMBIENT 40° C							
Enclosure ODP	IP 23	RATING CONTINUOUS							
NEMA CODE H	P.F. 0.86	MOTOR WEIGHT 554 LBS.							
NOM EFF 93.6	MIN EFF 92.4	CONNECTION 12 Lead 2Δ/Δ							
DOWN THRUST 3200	BASE DIAMETER 10 INCHES								
UPPER BEARING 6212	LOWER BEARING 7312B								
LUBRICATION MOBIL POLYREX EM	LUBRICATION MOBIL POLYREX EM								
NON-REVERSE RATCHET - BALL TYPE	SERIAL NO.								
Specifically designed for use on deep well turbine pump applications. Hernando, Mississippi	 	CC082A	PART WIND START CAPABLE @ 230V						
ROTATION 									

MOTOR IS SUITABLE FOR INVERTER RATED 20:1 VT

APPLICATIONS:

Specifically designed for use on deep well turbine pump applications. The coupling is equipped with a non-reverse ratchet, which prevents motor rotation from backspin at shutdown. These motors are built to NEMA standards and have special bearing arrangements to carry heavy thrust loads.