

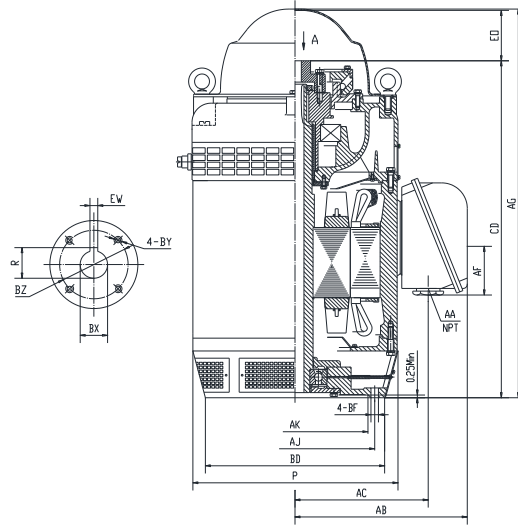

V2-300S4-W500624A-EHT

VERTICAL HOLLOW SHAFT MOTOR
NEMA PREMIUM EFFICIENCY
INVERTER DUTY 20:1 VT
INCLUDES INSULATED BEARING MOUNT - 40 HP AND ABOVE
EXTRA HIGH THRUST DESIGN
THREE PHASE, OPEN DRIP PROOF (WP1) ENCLOSURE
NON-REVERSE BALL TYPE RATCHET
COUPLING INCLUDED



DIMENSIONS

HP	RPM	Frame	MOUNTING DIMENSIONS													
			BD	AJ	AK	BF	BX	BZ	EW	R	BY	CD	E0 >	AC	AA	AF
300	1790	5006P	24.5	14.75	13.5	0.69	1-11/16	2.5	0.375	1.854	1/4-20	49.75	8.1	22.24	2-NPT3	7.87

OVERALL DIMENSIONS			BEARINGS	
P	AB	AG	UPPER	LOWER
28.98	27.38	57.75	7236B/DT	6322

COUPLING: Motor comes with a 1.69" coupling. You may select a different size coupling at no extra charge.

BEARING LUBRICATION: The lower bearing comes lubricated with Mobil Polyrex EM Polyurea Grease.

OIL RESERVOIR: Motor is shipped without oil. The oil capacity is 11.08 quarts.

STEADY BUSHING: Motor is designed to accept a steady bushing. The bore size is 1-11/16 inches.





V2-300S4-W500624A-EHT







VERTICAL HOLLOW SHAFT MOTOR
NEMA PREMIUM EFFICIENCY
INVERTER DUTY 20:1 VT
INCLUDES INSULATED BEARING MOUNT - 40 HP AND ABOVE
EXTRA HIGH THRUST DESIGN
THREE PHASE, OPEN DRIP PROOF (WP1) ENCLOSURE
NON-REVERSE BALL TYPE RATCHET
COUPLING INCLUDED

PERFORMANCE DATA

HP	RPM	Frame	Voltage	Frequency (Hz)	Full Load S.F.	Insulation Class	NEMA Design	Slip (%)	NEMA Code	Enclosure Type	IP Rating	Max. Ambient	Rating CONT
300	1790	5006P	460	60	1.15	F	B	0.55	G	WP1	23	40° C	S1

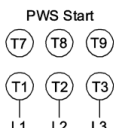
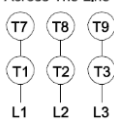
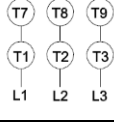
Amps (460V)		Efficiency (%)				Power Factor			Torque (ft-lb)			Down Thrust	Angular Contact Bearing	Radial Ball Bearing	Connection	Weight (lbs.)
FLA	LRA	100%	75%	50%	Min.	100%	75%	50%	FLT	LRT %	BDT %	24000	UPPER	LOWER	6 Lead Δ	3693
328	2328	95.8	94.9	93.5	95.0	0.90	0.85	0.80	876	188	230		7236B/DT	6322		

NAME PLATE

 VERTICAL HOLLOW SHAFT EXTRA HIGH THRUST DESIGN												CONNECTION DIAGRAMS	
MODEL V2-300S4-W500624A-EHT					FRAME 5006P								
Hz	60	S.F.	1.15	ENCL	WP1	DESIGN	B						
HP	300	RPM	1790	INS	F	PHASE	3						
VOLTS	460	FLA	328	MAX.AMBIENT		40° C							
Enclosure	ODP	IP	23	RATING		CONTINUOUS							
NEMA CODE	G	P.F.	0.90	MOTOR WEIGHT		3693	LBS.						
NOM EFF	95.8	MIN EFF	95.0	CONNECTION		6 Lead Δ							
DOWN THRUST		24000		BASE DIAMETER		24.5	INCHES						
UPPER BEARING		7236B/DT (X 2) EHT		LOWER BEARING		6322							
OIL CAP. UPPER BEARING		11.08 QTS.		LUBRICATION		MOBIL POLYREX EM							
NON-REVERSE RATCHET - BALL TYPE				SERIAL NO.									
Specifically designed for use on deep well turbine pump applications.								CC326B		PART WIND START CAPABLE @ 230V			
Hernando, Mississippi		ROTATION											
MOTOR IS SUITABLE FOR INVERTER RATED 20:1 VT													

APPLICATIONS:

Specifically designed for use on deep well turbine pump applications. The coupling is equipped with a non-reverse ratchet, which prevents motor rotation from backspin at shutdown. These motors are built to NEMA standards and have special bearing arrangements to carry heavy thrust loads.