

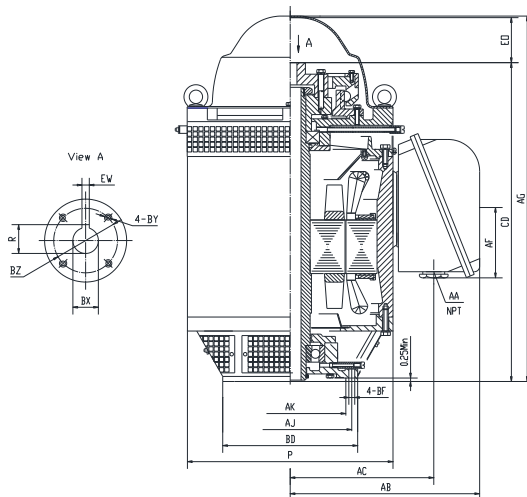

V2-30D4-W28610A

VERTICAL HOLLOW SHAFT MOTOR
NEMA PREMIUM EFFICIENCY
INVERTER DUTY 20:1 VT
INCLUDES INSULATED BEARING MOUNT - 40 HP AND ABOVE
HIGH THRUST DESIGN
THREE PHASE, OPEN DRIP PROOF (WP1) ENCLOSURE
NON-REVERSE BALL TYPE RATCHET
COUPLING INCLUDED



DIMENSIONS

HP	RPM	Frame	MOUNTING DIMENSIONS													
			BD	AJ	AK	BF	BX	BZ	EW	R	BY	CD	E0 >	AC	AA	AF
30	1785	286TP	10	9.125	8.25	0.44	1	1.38	0.25	1.114	10-32	24.75	3.22	10.6	3	5.83

OVERALL DIMENSIONS			BEARINGS	
P	AB	AG	UPPER	LOWER
15.24	14.39	28.2	6212	7312B

COUPLING: Motor comes with a 1.0" coupling. You may select a different size coupling at no extra charge.

BEARING LUBRICATION: The bearings comes lubricated with Mobil Polyrex EM Polyurea Grease.

STEADY BUSHING: Motor is designed to accept a steady bushing. The bore size is 1 inches.





V2-30D4-W28610A







VERTICAL HOLLOW SHAFT MOTOR
NEMA PREMIUM EFFICIENCY
INVERTER DUTY 20:1 VT
INCLUDES INSULATED BEARING MOUNT - 40 HP AND ABOVE
HIGH THRUST DESIGN
THREE PHASE, OPEN DRIP PROOF (WP1) ENCLOSURE
NON-REVERSE BALL TYPE RATCHET
COUPLING INCLUDED

PERFORMANCE DATA

HP	RPM	Frame	Voltage	Frequency (Hz)	Full Load S.F.	Insulation Class	NEMA Design	Slip (%)	NEMA Code	Enclosure Type	IP Rating	Max. Ambient	Rating CONT
30	1780	286TP	230/460	60	1.15	F	B	1.15	H	WP1	23	40° C	S1

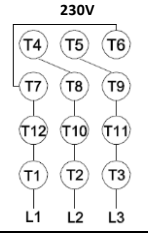
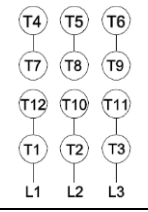
Amps (460V)		Efficiency (%)				Power Factor			Torque (ft-lb)			Down Thrust	Radial Ball Bearing	Angular Contact Bearing	Connection	Weight (lbs.)
FLA	LRA	100%	75%	50%	Min.	100%	75%	50%	FLT	LRT %	BDT %	3200	UPPER	LOWER	12 Lead 2Δ/Δ	572
34.1	246	94.1	93.9	92.9	93.0	0.86	0.83	0.74	85	236	275		6212	7312B		

NAME PLATE

 VERTICAL HOLLOW SHAFT HIGH THRUST DESIGN 							CONNECTION DIAGRAMS			
MODEL V2-30D4-W28610A				FRAME 286TP						
Hz	60	S.F.	1.15	ENCL	WP1	DESIGN				B
HP	30	RPM	1780	INS	F	PHASE	3			
VOLTS	230/460	FLA	68.2/34.1	MAX.AMBIENT 40° C						
Enclosure	ODP	IP	23	RATING CONTINUOUS						
NEMA CODE	H	P.F.	0.86	MOTOR WEIGHT 572 LBS.						
NOM EFF	94.1	MIN EFF	93.0	CONNECTION 12 Lead 2Δ/Δ						
DOWN THRUST 3200		BASE DIAMETER 10 INCHES								
UPPER BEARING 6212		LOWER BEARING 7312B								
LUBRICATION MOBIL POLYREX EM		LUBRICATION MOBIL POLYREX EM								
NON-REVERSE RATCHET - BALL TYPE		SERIAL NO.								
Specifically designed for use on deep well turbine pump applications. Hernando, Mississippi		  		CC326B		PART WIND START CAPABLE @ 230V				
		ROTATION 								
MOTOR IS SUITABLE FOR INVERTER RATED 20:1 VT										

APPLICATIONS:

Specifically designed for use on deep well turbine pump applications. The coupling is equipped with a non-reverse ratchet, which prevents motor rotation from backspin at shutdown. These motors are built to NEMA standards and have special bearing arrangements to carry heavy thrust loads.