

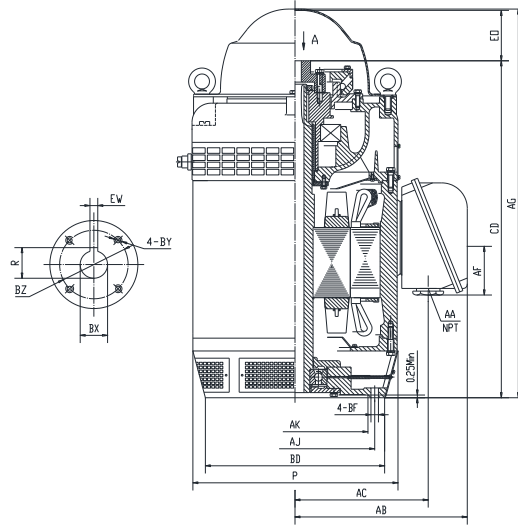

V2-75D4-W36516A

VERTICAL HOLLOW SHAFT MOTOR
NEMA PREMIUM EFFICIENCY
INVERTER DUTY 20:1 VT
INCLUDES INSULATED BEARING MOUNT - 40 HP AND ABOVE
HIGH THRUST DESIGN
THREE PHASE, OPEN DRIP PROOF (WP1) ENCLOSURE
NON-REVERSE BALL TYPE RATCHET
COUPLING INCLUDED



DIMENSIONS

HP	RPM	Frame	MOUNTING DIMENSIONS													
			BD	AJ	AK	BF	BX	BZ	EW	R	BY	CD	E0 >	AC	AA	AF
75	1787	365TP	16.5	14.75	13.5	0.69	1-1/4	1.75	0.25	1.366	1-4/20	31.16	4.56	12.56	3	5.83

OVERALL DIMENSIONS			BEARINGS	
P	AB	AG	UPPER	LOWER
19.1	16.32	36	7224B	6314

COUPLING: Motor comes with a 1.25" coupling. You may select a different size coupling at no extra charge.

BEARING LUBRICATION: The lower bearing comes lubricated with Mobil Polyrex EM Polyurea Grease.

OIL RESERVOIR: Motor is shipped without oil. The oil capacity is 1.94 quarts.

STEADY BUSHING: Motor is designed to accept a steady bushing. The bore size is 1-1/4 inches.





V2-75D4-W36516A







VERTICAL HOLLOW SHAFT MOTOR
NEMA PREMIUM EFFICIENCY
INVERTER DUTY 20:1 VT
INCLUDES INSULATED BEARING MOUNT - 40 HP AND ABOVE
HIGH THRUST DESIGN
THREE PHASE, OPEN DRIP PROOF (WP1) ENCLOSURE
NON-REVERSE BALL TYPE RATCHET
COUPLING INCLUDED

PERFORMANCE DATA

HP	RPM	Frame	Voltage	Frequency (Hz)	Full Load S.F.	Insulation Class	NEMA Design	Slip (%)	NEMA Code	Enclosure Type	IP Rating	Max. Ambient	Rating CONT
75	1785	365TP	230/460	60	1.15	F	B	0.79	H	WP1	23	40° C	S1

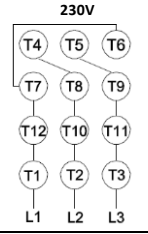
Amps (460V)		Efficiency (%)				Power Factor			Torque (ft-lb)			Down Thrust	Angular Contact Bearing	Radial Ball Bearing	Connection	Weight (lbs.)
FLA	LRA	100%	75%	50%	Min.	100%	75%	50%	FLT	LRT %	BDT %	5600	UPPER	LOWER	12 Lead 2Δ/Δ	1053
85	665	95.0	94.7	93.5	94.1	0.87	0.85	0.79	217	235	270		7224B	6314		

NAME PLATE

 VERTICAL HOLLOW SHAFT HIGH THRUST DESIGN 							CONNECTION DIAGRAMS			
MODEL V2-75D4-W36516A				FRAME 365TP						
Hz	60	S.F.	1.15	ENCL	WP1	DESIGN				B
HP	75	RPM	1785	INS	F	PHASE				3
VOLTS	230/460	FLA	170/85	MAX.AMBIENT 40° C						
Enclosure	ODP	IP	23	RATING CONTINUOUS						
NEMA CODE	H	P.F.	0.87	MOTOR WEIGHT 1053		LBS.				
NOM EFF	95.0	MIN EFF	94.1	CONNECTION		12 Lead 2Δ/Δ				
DOWN THRUST		5600		BASE DIAMETER		16.5 INCHES				
UPPER BEARING		7224B		LOWER BEARING		6314				
OIL CAP. UPPER BEARING		1.94 QTS.		LUBRICATION MOBIL POLYREX EM						
NON-REVERSE RATCHET - BALL TYPE				SERIAL NO.						
Specifically designed for use on deep well turbine pump applications. Hernando, Mississippi								CC326B		
ROTATION								PART WIND START CAPABLE @ 230V		

MOTOR IS SUITABLE FOR INVERTER RATED 20:1 VT

APPLICATIONS:

Specifically designed for use on deep well turbine pump applications. The coupling is equipped with a non-reverse ratchet, which prevents motor rotation from backspin at shutdown. These motors are built to NEMA standards and have special bearing arrangements to carry heavy thrust loads.